

1410

0.251 Kg/m

ÇITA

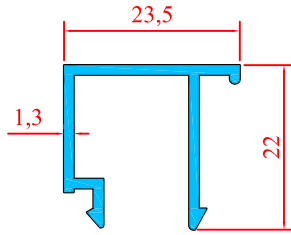

1421

0.230 Kg/m

CAM ÇITASI

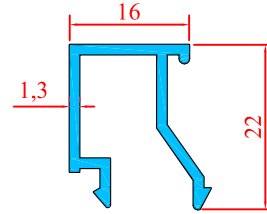

1438

1.105 Kg/m

BAĞLANTI

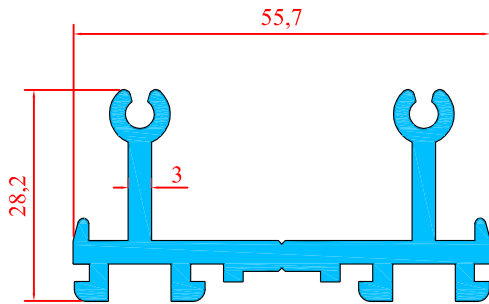

1413

0.470 Kg/m

KAPI TIRNAK ADAPTÖRÜ

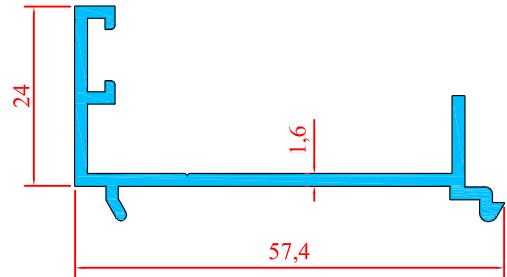

3609

0.335 Kg/m

ÇARPMA KAPI ADAPTÖRÜ

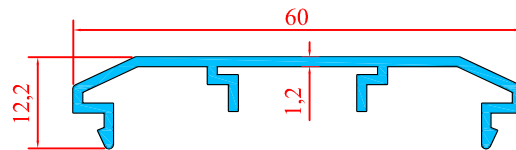

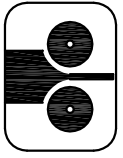

1411
KASA

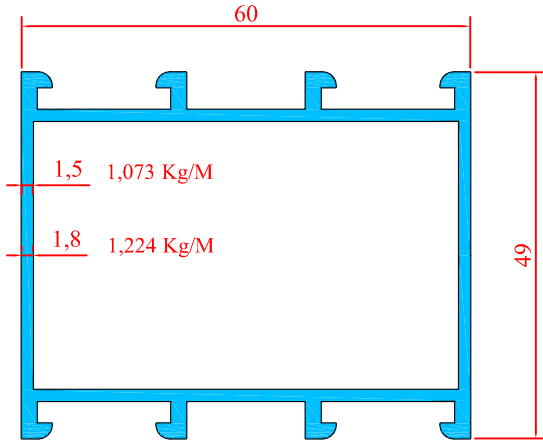

1412
KANAT

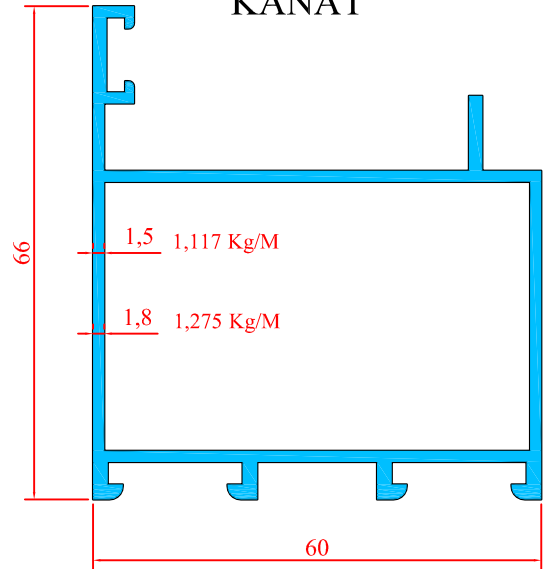

1414
ALT ETEK

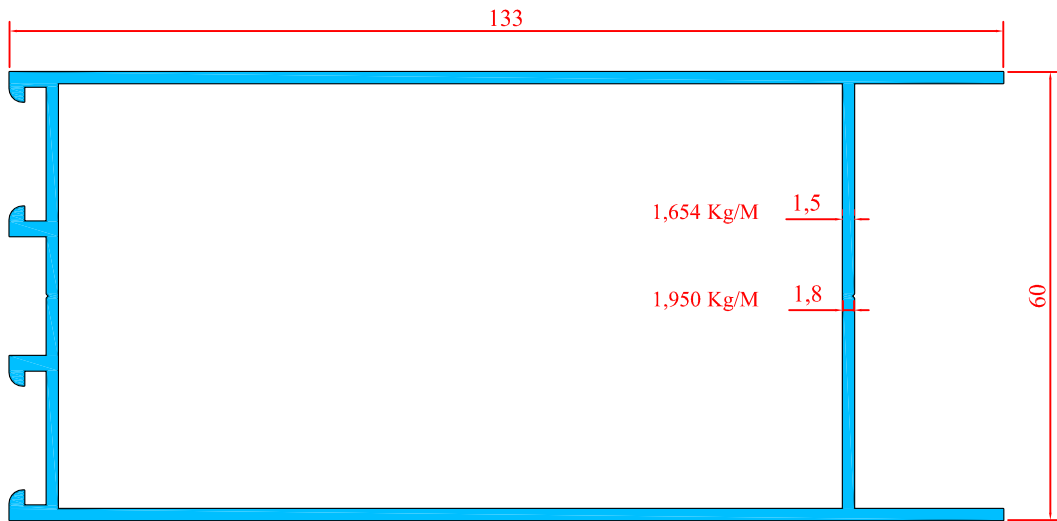

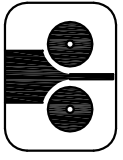

1416
1.940 Kg/m
KASA

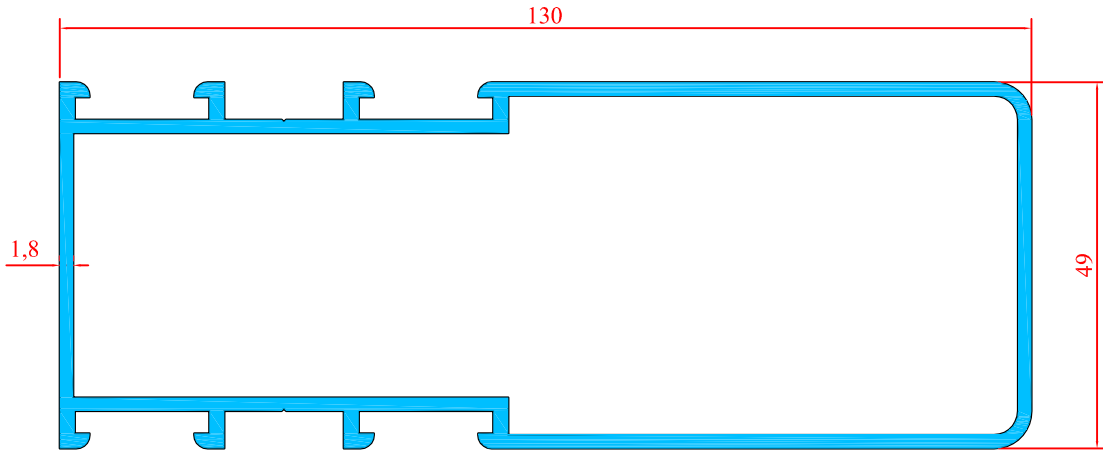

1417
1.615 Kg/m
KASA

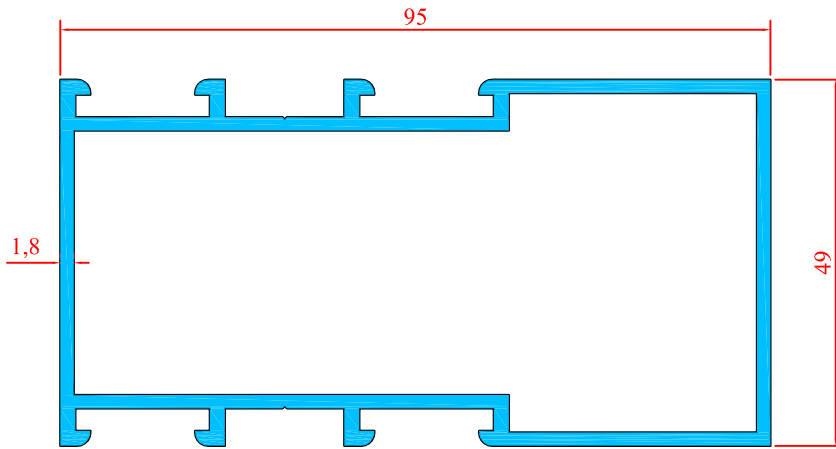

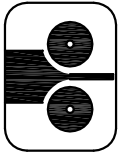

1425
KASA

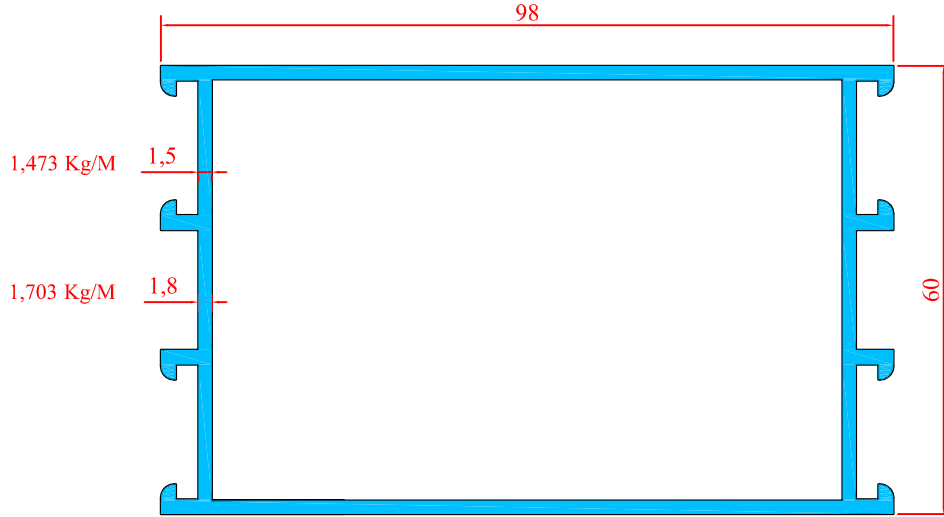

1415
1.305 Kg/m

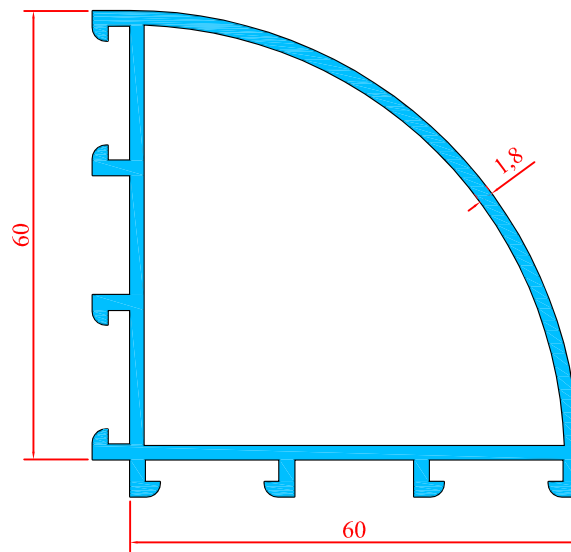

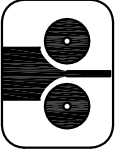

1439
3.113 Kg/m
KÖŞE TAKOZU

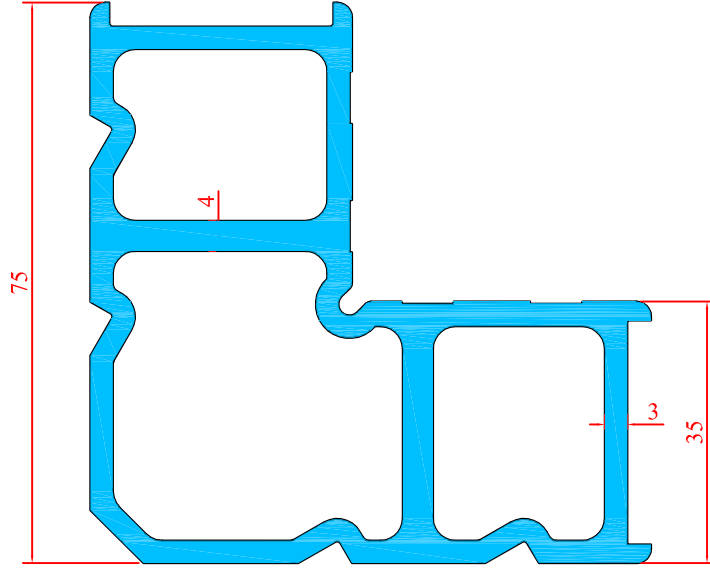

1420
0.931 Kg/m
DAR KASA

