

1900
0.690 Kg/m

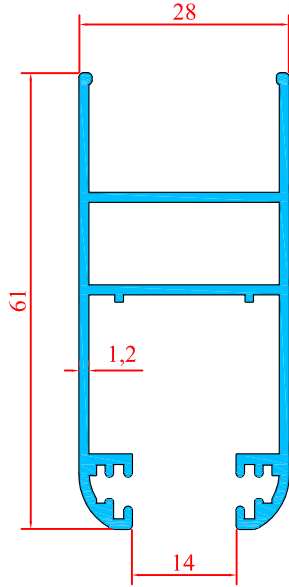

1901
0.722 Kg/m

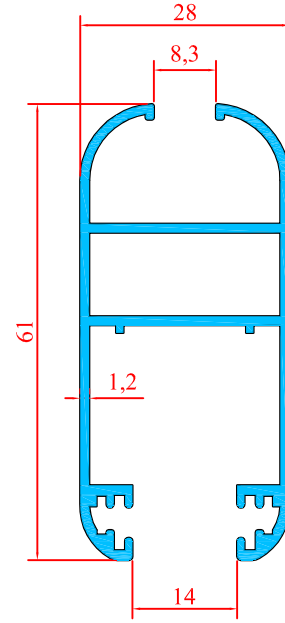

1902
0.318 Kg/m

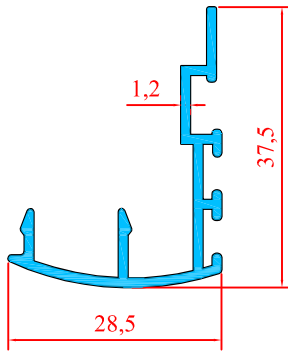

1903
0.791 Kg/m

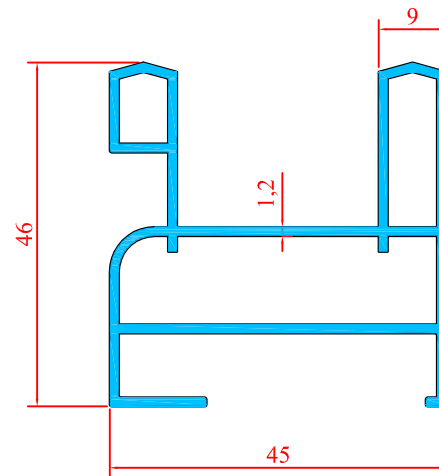

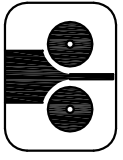

1904
0.693 Kg/m

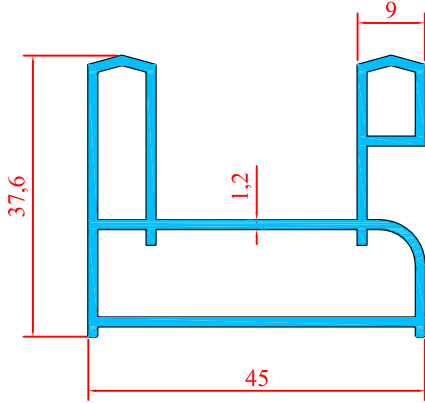

1905
0.984 Kg/m

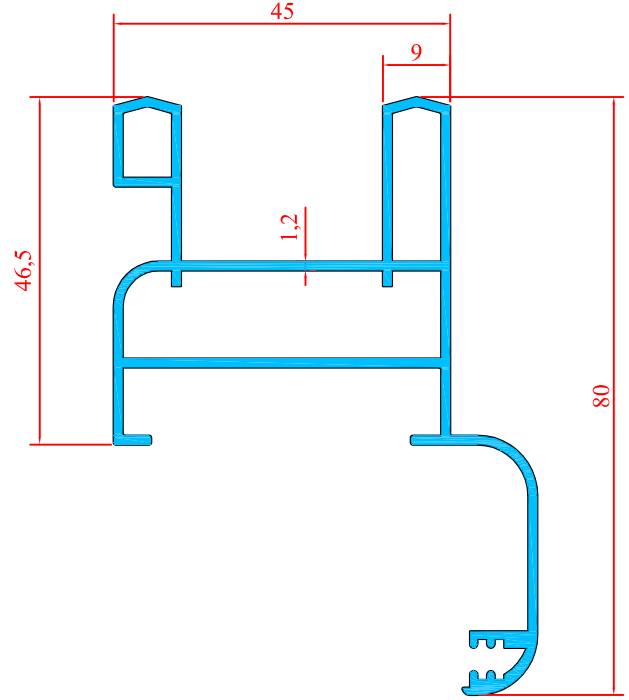

1906
0.930 Kg/m

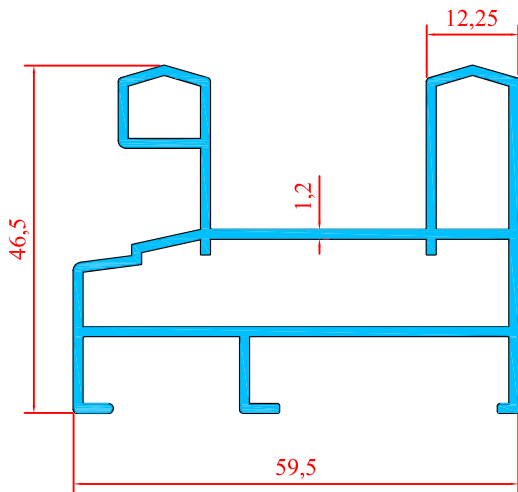

1907
0.778 Kg/m

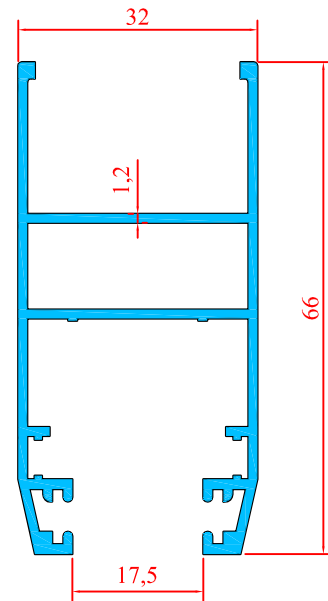

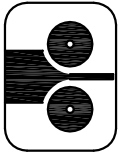

1908
0.341 Kg/m

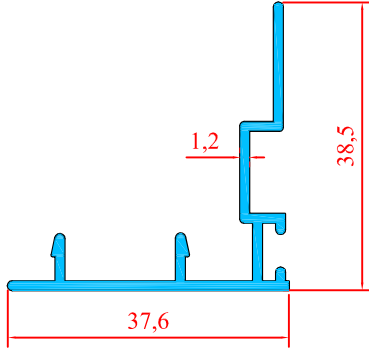

1909
0.750 Kg/m

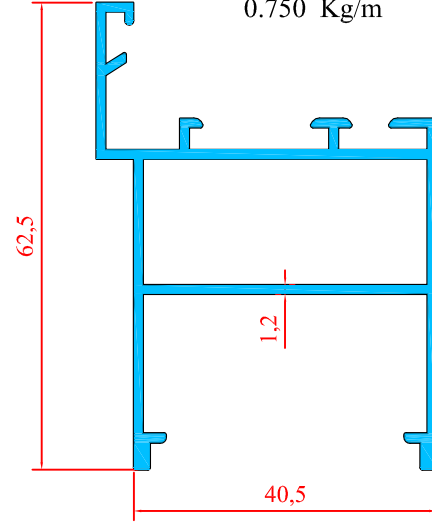

1910
0.887 Kg/m

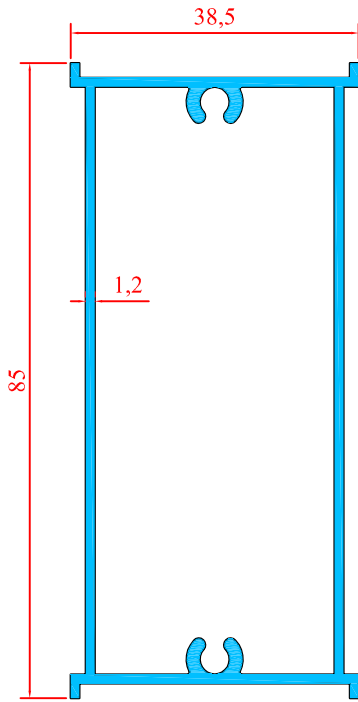

1911
0.916 Kg/m

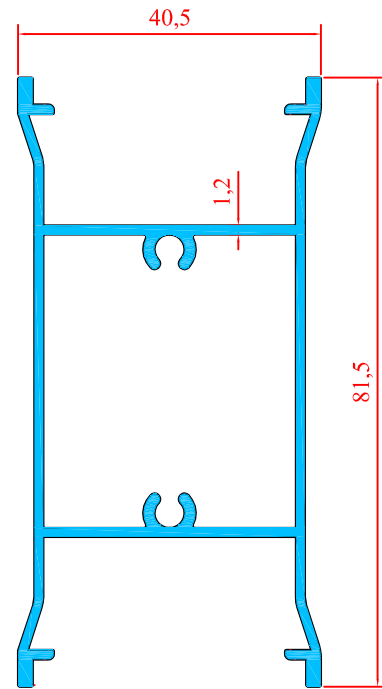

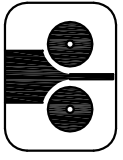

1912
0.593 Kg/m

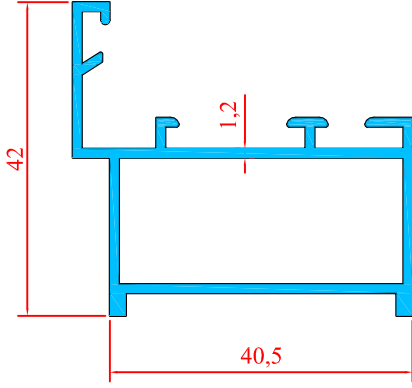

1915
0.449 Kg/m

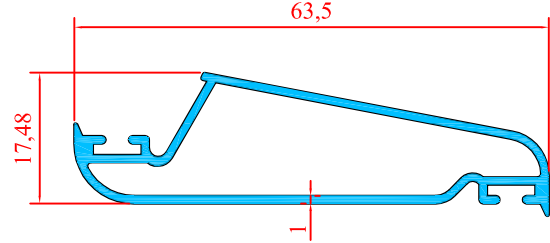

1914
0.963 Kg/m

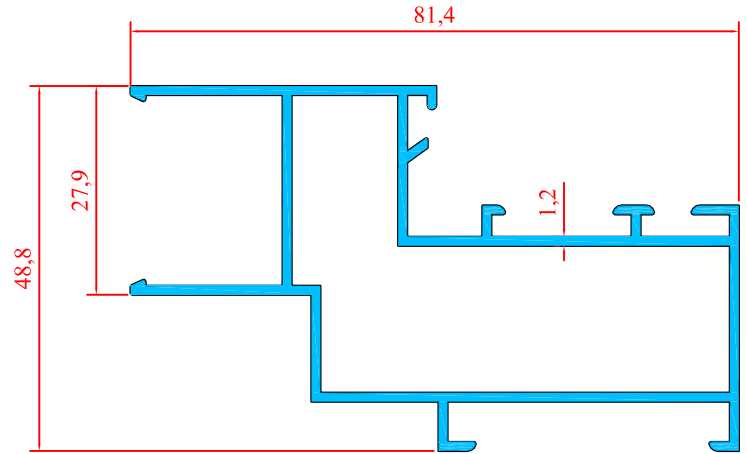

1913
1.512 Kg/m

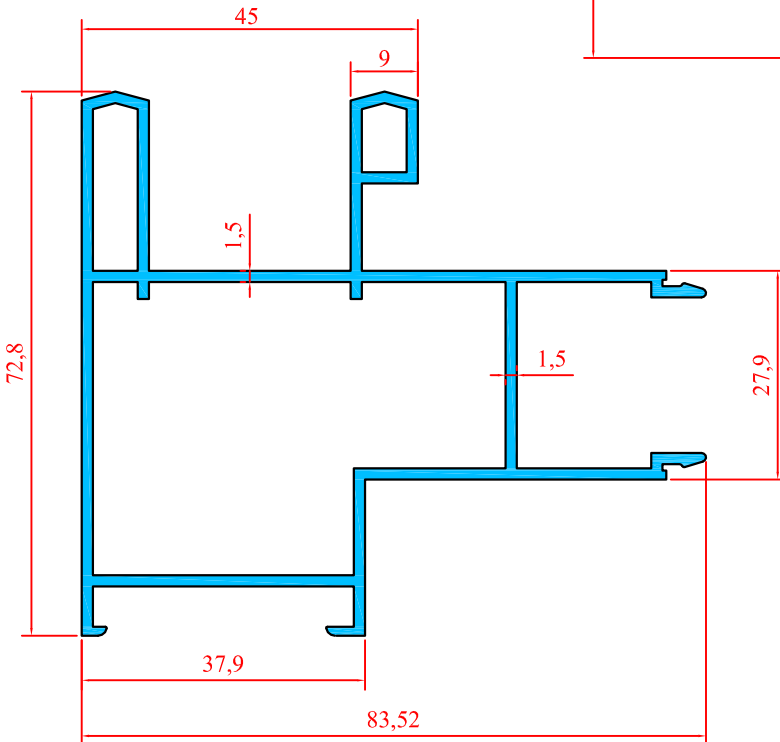

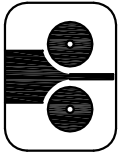

1916
0.331 Kg/m

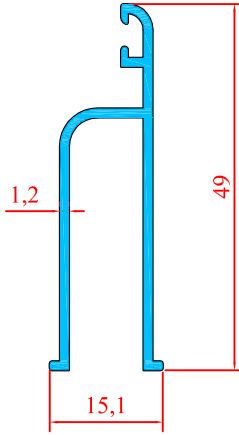

1917
0.491 Kg/m

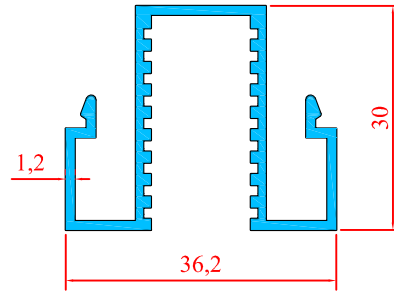

1918
0.355 Kg/m

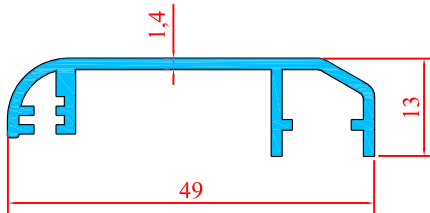

1919
0.417 Kg/m

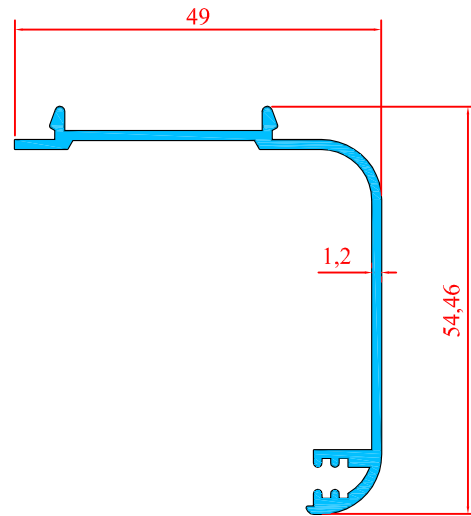

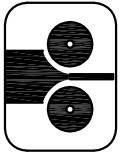

1920
0.194 Kg/m

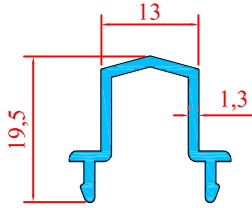

1921
0.185 Kg/m

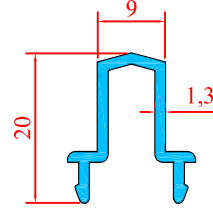

1922
0.287 Kg/m

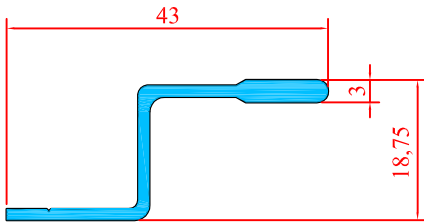

1924
0.580 Kg/m

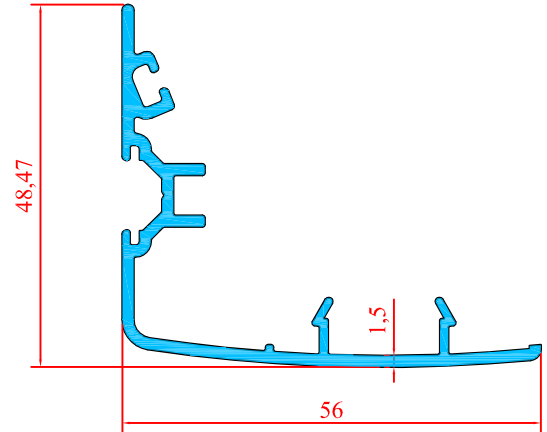

1923
0.310 Kg/m

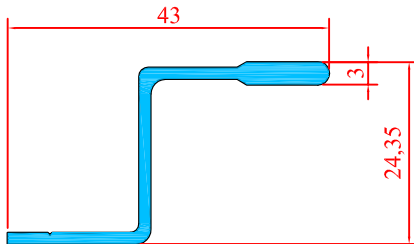

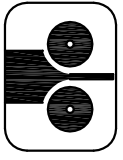

ALÇIN
Alüminyum A.Ş.

KIBRIS SÜRME SERİ

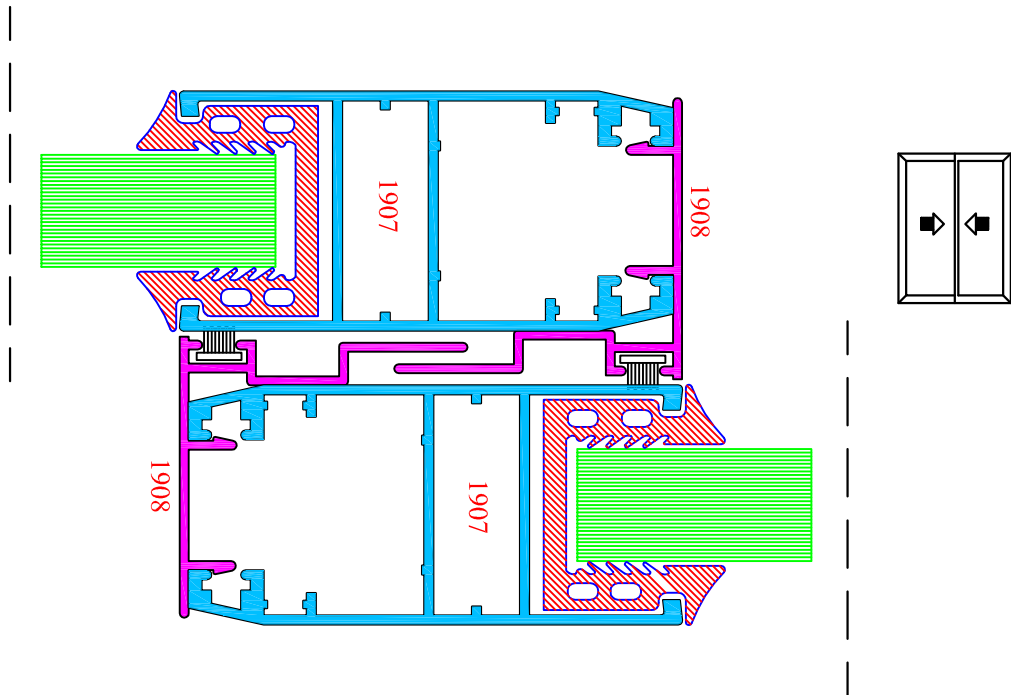
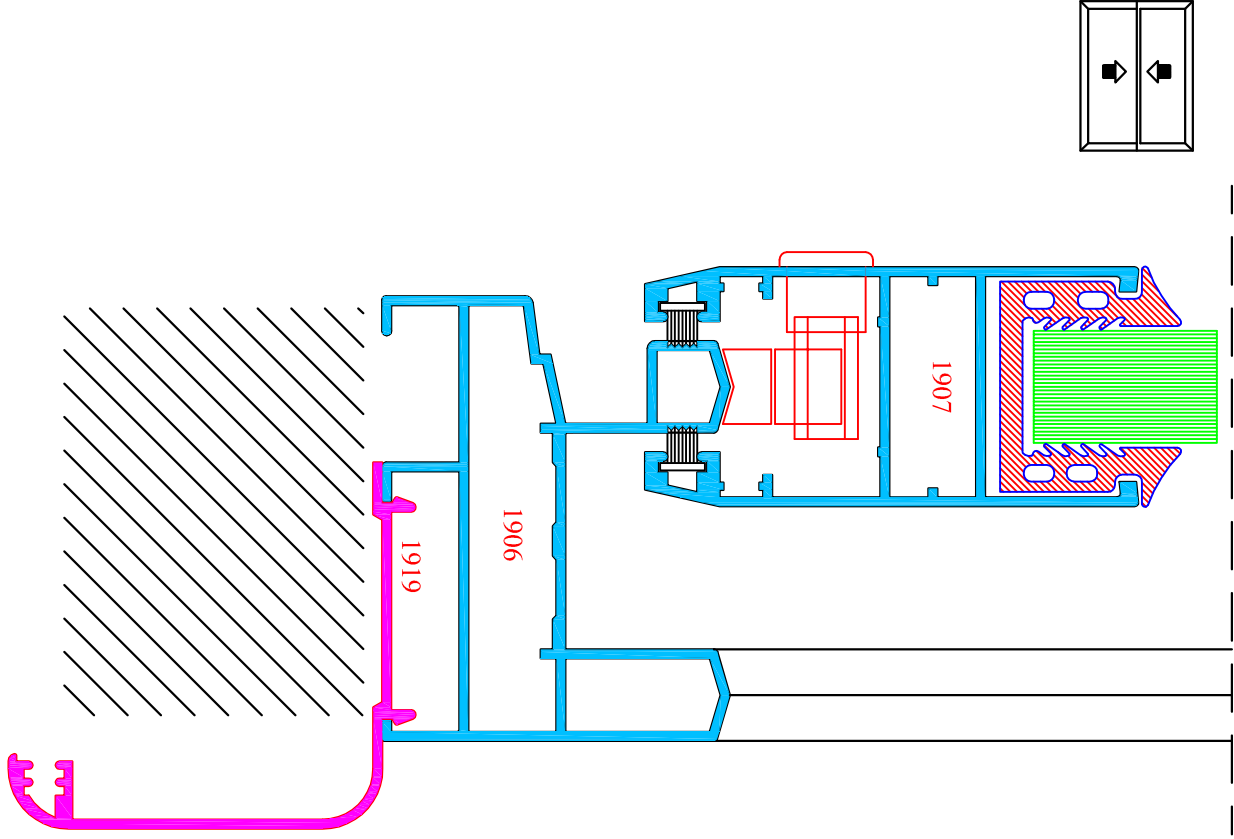

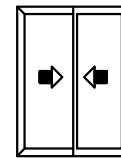
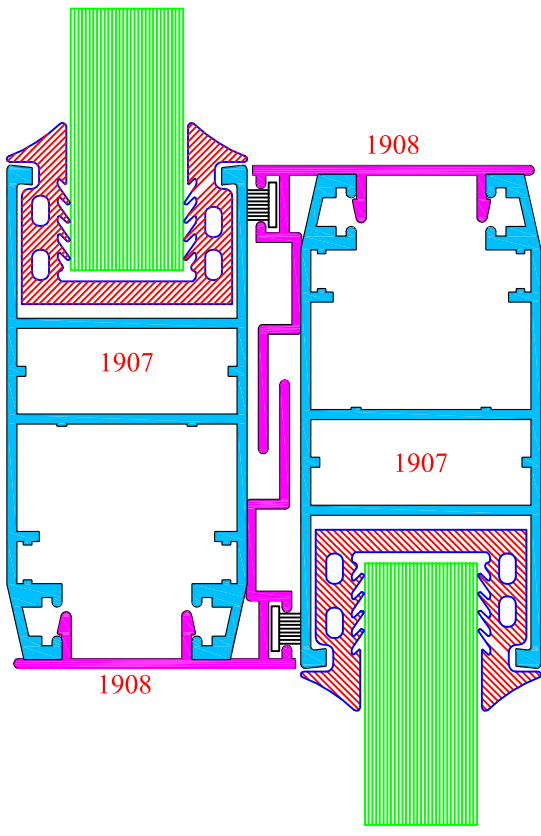
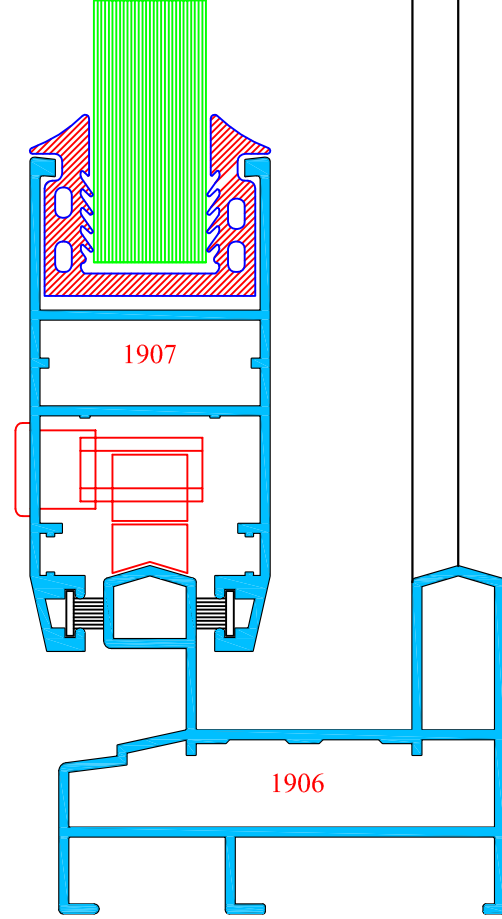
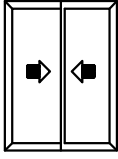
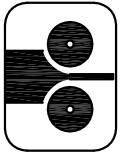

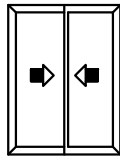
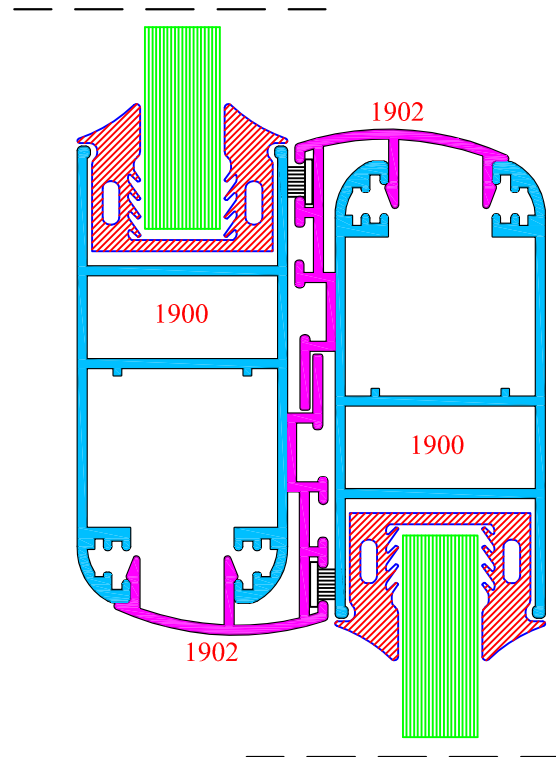
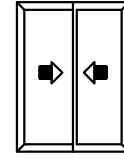
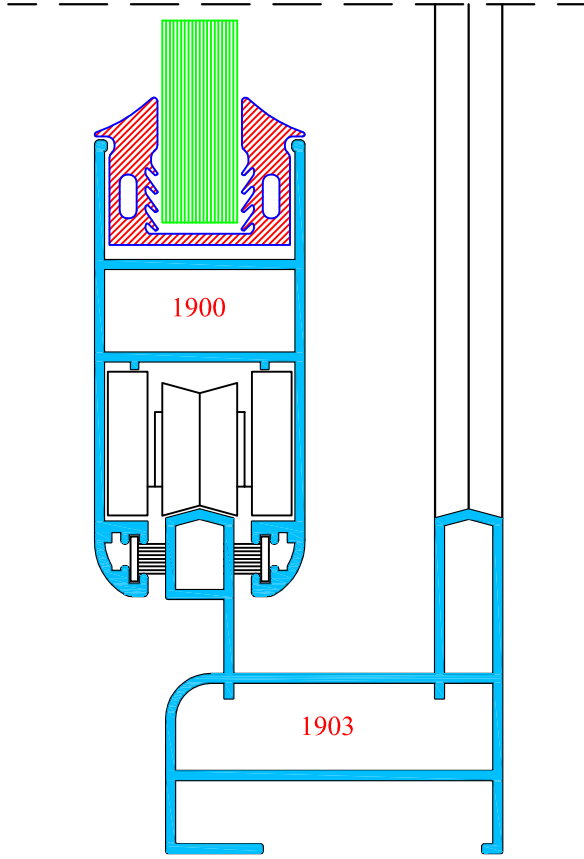
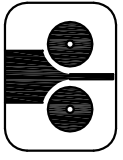

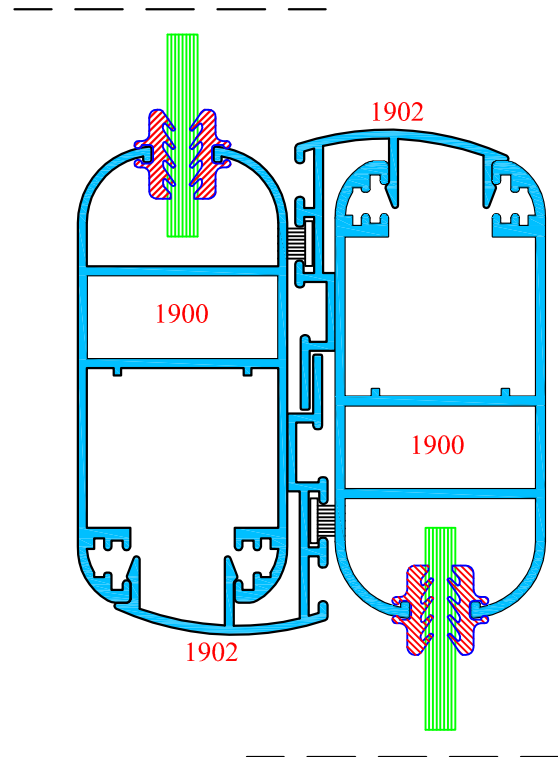
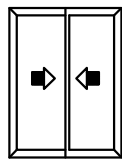
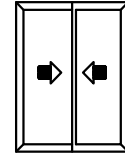
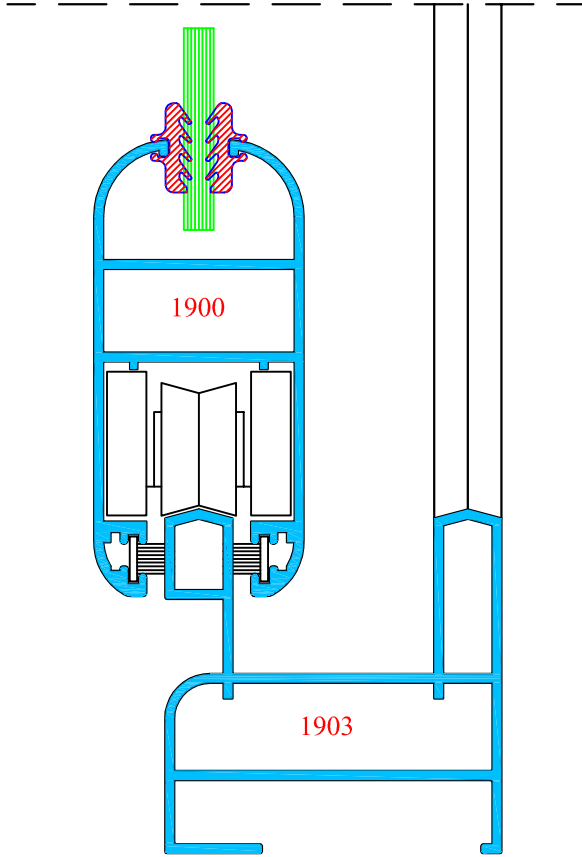
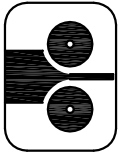



ALÇIN
Alüminyum A.Ş.

KIBRIS SÜRME SERİSİ

