

2517  
1.205 Kg/m

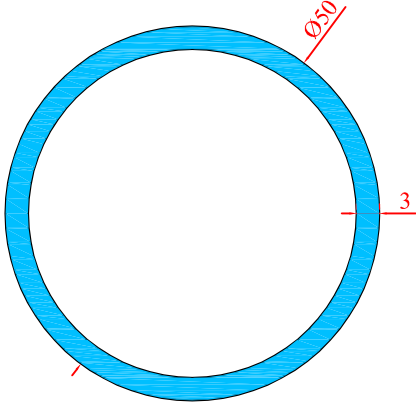

2567  
1.015 Kg/m

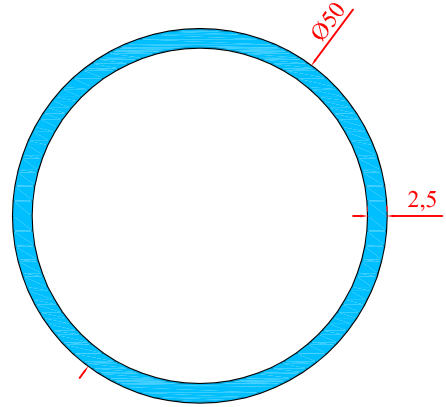

2571  
0.820 Kg/m

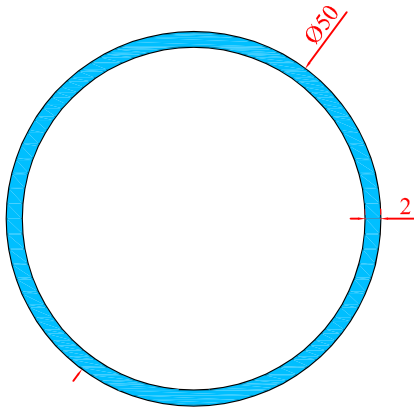

2516  
0.622 Kg/m

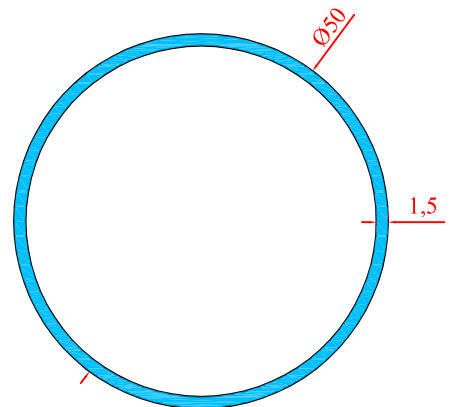

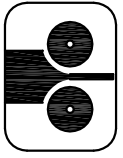

2526  
0.949 Kg/m

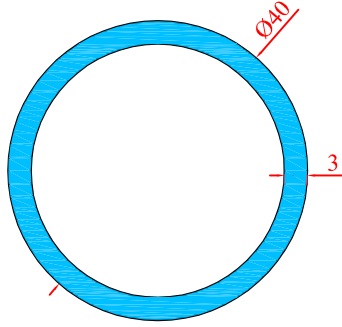

2524  
0.801 Kg/m

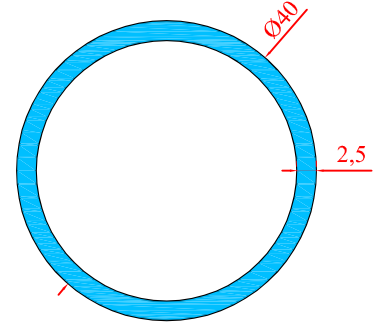

2522  
0.649 Kg/m

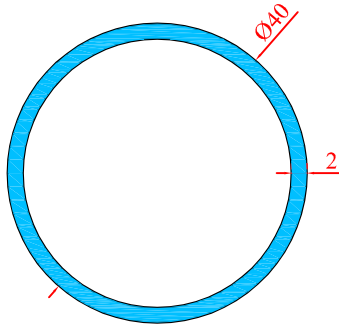

2510  
0.820 Kg/m

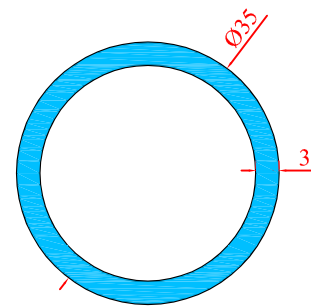

2508  
0.692 Kg/m

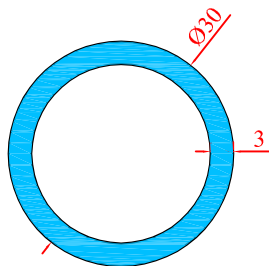

2514  
0.587 Kg/m

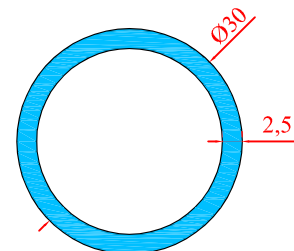

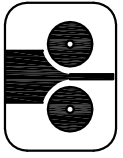

2505

0.154 Kg/m

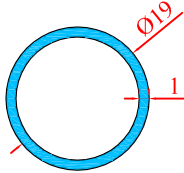

2569

0.333 Kg/m

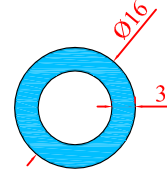

2568

0.470 Kg/m

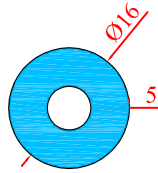

2572

0.239 Kg/m

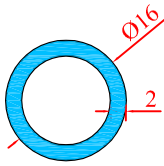

2553

0.186 Kg/m

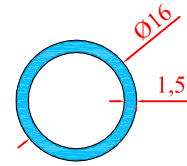

3698

1.268 Kg/m

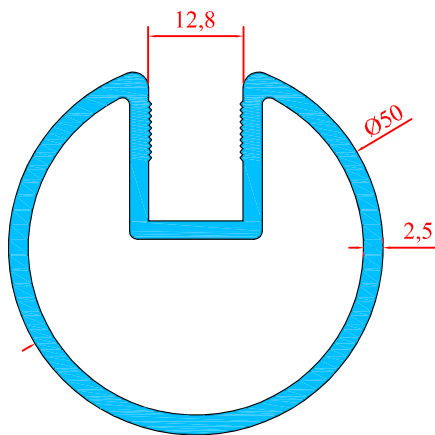

3464

1.275 Kg/m

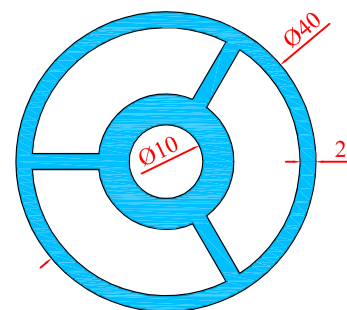

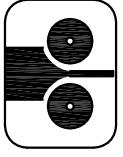

**3677**  
0.785 Kg/m

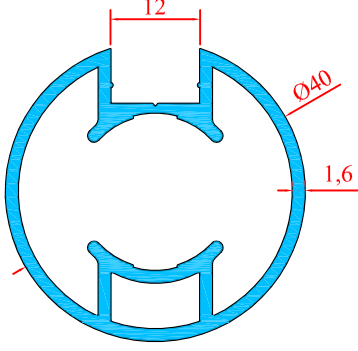

**3453**  
1.054 Kg/m  
40 LİK DİKME PETEKLİ

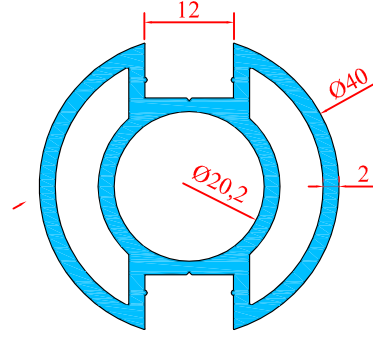

**3452**  
0.068 Kg/m  
40 LİK DİKME ÇITASI

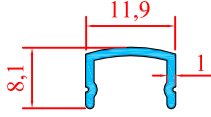

**3466**  
0.052 Kg/m  
30 LUK DİKME ÇITASI

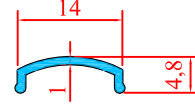

**3465**  
0.949 Kg/m  
30 LUK DİKME PROFİLİ

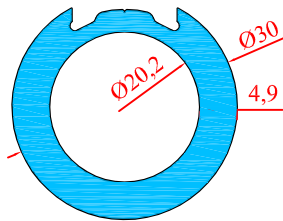

**3469**  
0.866 Kg/m  
40 LİK DİKME PETEKSİZ

