

**2099**

0.667 Kg/m

RAYSIZ SÜRME KASA

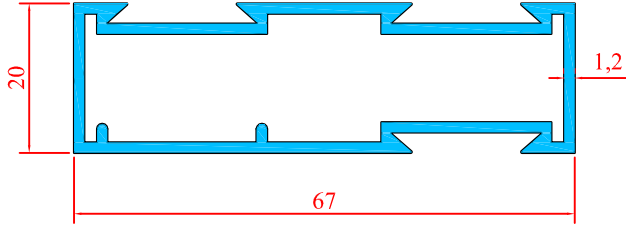

**2100**

0.568 Kg/m

SÜRME KANAT

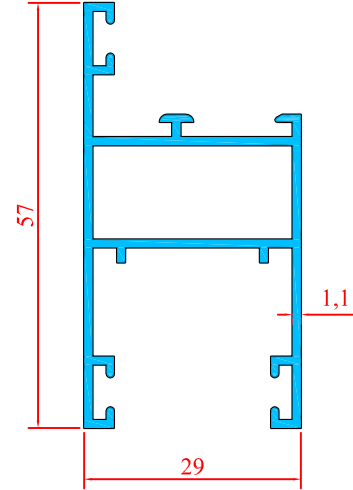

**2101**

0.325 Kg/m

ÇITA ADAPTÖR

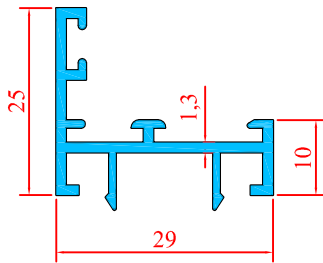

**2102**

0.202 Kg/m

ÇITA

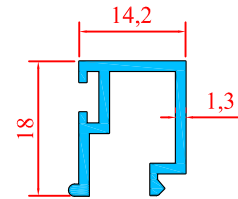

**2103**

0.239 Kg/m

KAPAK

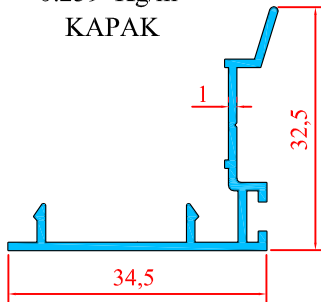

**2104**

0.141 Kg/m

RAY

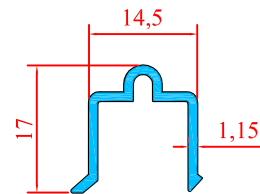

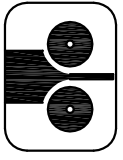

**2105**

0.155 Kg/m  
S PROFİLİ

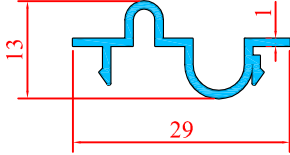

**2106**

0.143 Kg/m  
ISI CAM ÇITASI

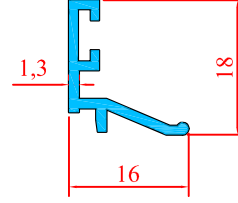

**2107**

1.308 Kg/m  
SÜRME KASA

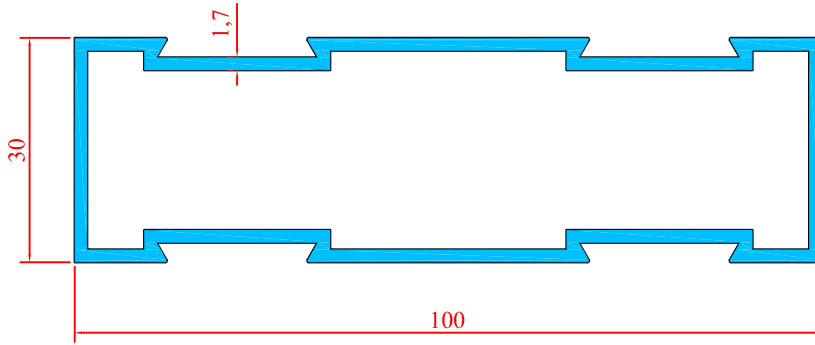

**2108**

1.108 Kg/m  
SÜRME KANAT

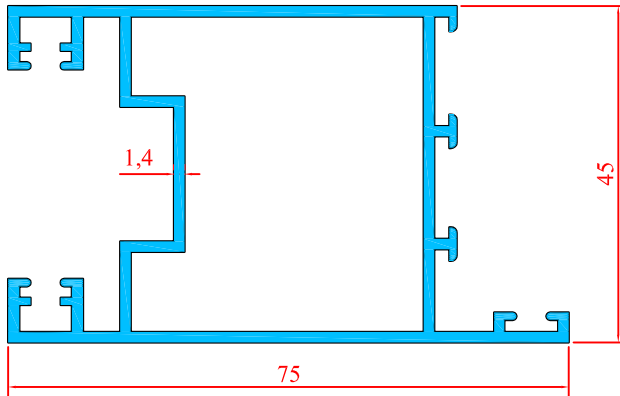

**2109**

0.443 Kg/m  
ÇITA ADAPTÖR

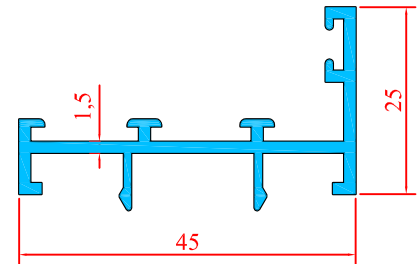

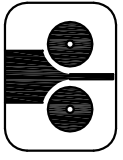

**2110**

0.899 Kg/m  
SABİT KASA

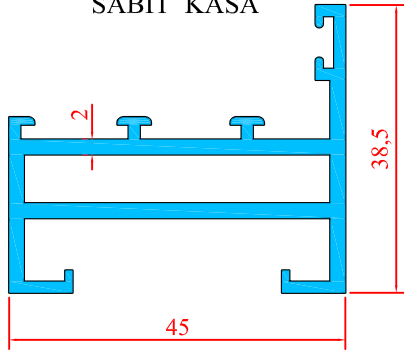

**2111**

0.443 Kg/m  
KAPAK

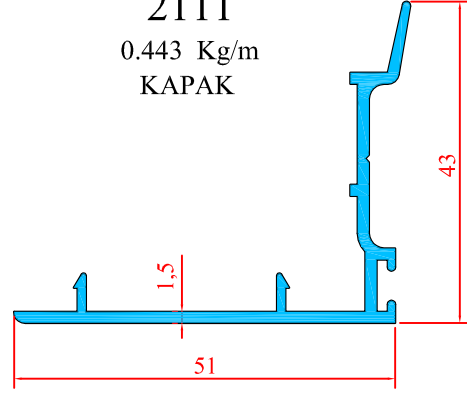

**2112**

0.257 Kg/m  
RAY

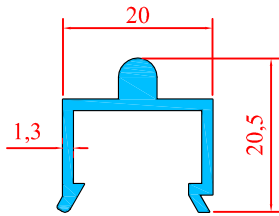

**2115**

0.159 Kg/m  
KÖR KASA BİNİSİ

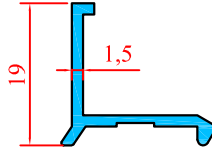

**2113**

0.302 Kg/m  
S PROFİLİ

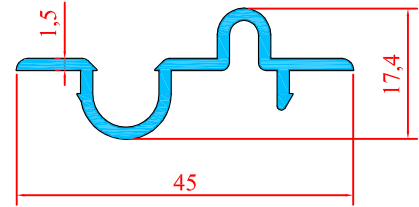

**2114**

0.877 Kg/m

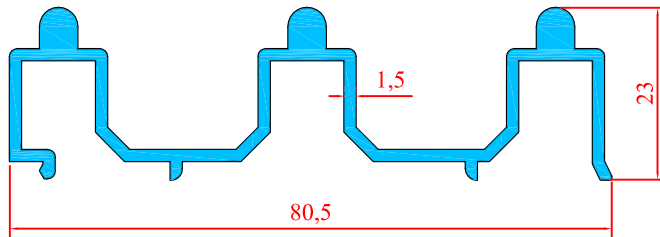

**2116**

0.175 Kg/m  
ISICAM ÇITA

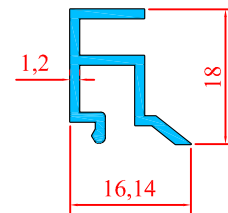

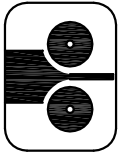

**2118**

0.513 Kg/m  
BAĞLANTI

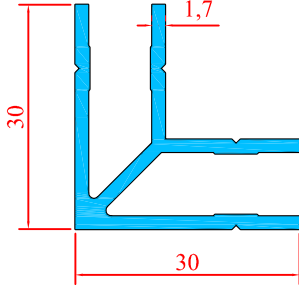

**2119**

0.941 Kg/m  
SİNEKLİKLİ KASA

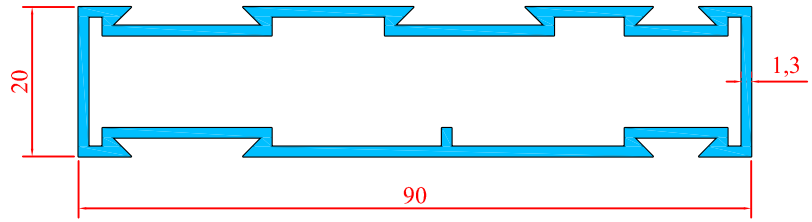

**2120**

0.652 Kg/m  
ÇITALI SİNEKLİK KANAT

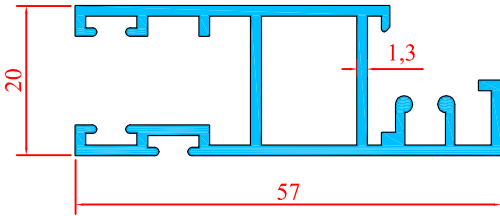

**2121**

0.161 Kg/m  
ÇITA

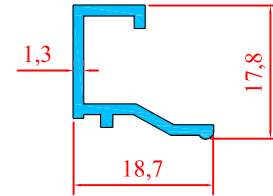

**2122**

0.089 Kg/m  
MİNİ RAY

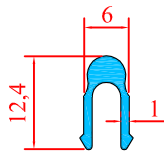

**2123**

0.112 Kg/m  
KÖR KASA BİNİSİ

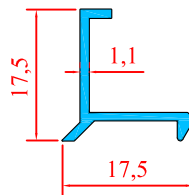

**2127**

0.138 Kg/m  
ÜST RAY

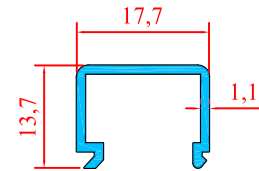

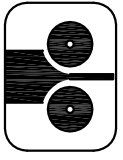

**2125**  
0.232 Kg/m  
B. SÜRME UST RAY

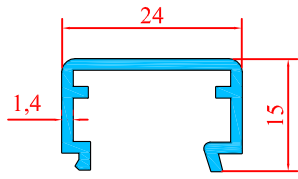

**2126**  
3.173 Kg/m  
BAĞLANTI

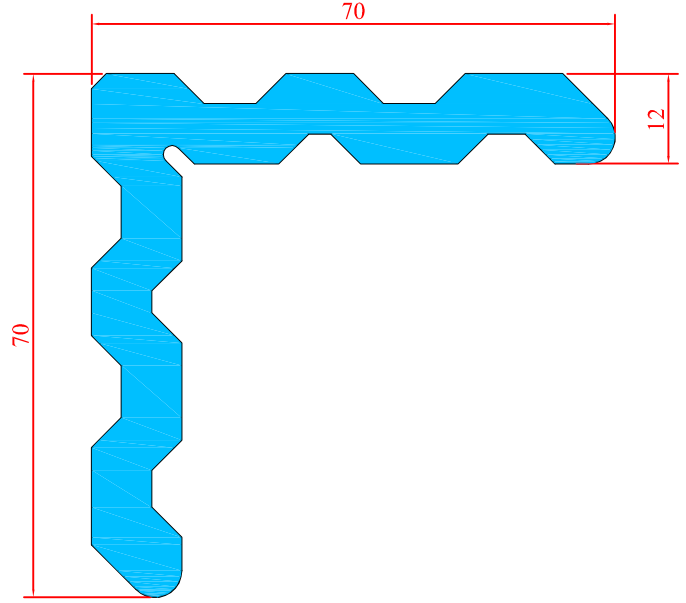

**2128**  
0.827 Kg/m  
RAYLI KASA

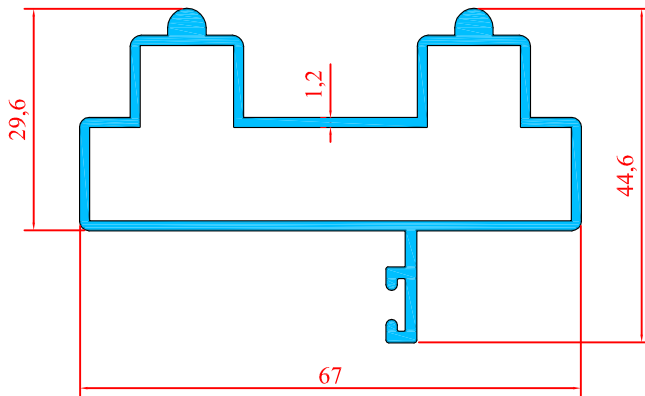

**2129**  
0.268 Kg/m  
SİNEKLİK SÜRME RAY

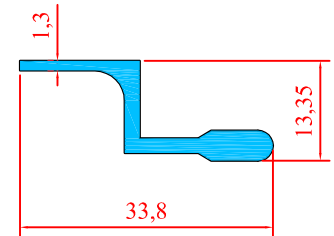

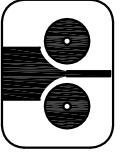

2138

0.366 Kg/m  
KANARYA KAPAK

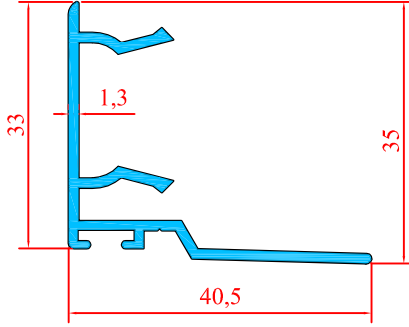

2139

0.980 Kg/m  
TERLEMELİ KASA

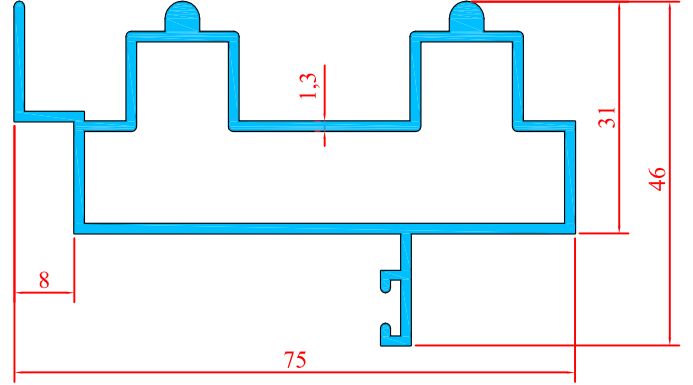

2145

0.738 Kg/m  
M. ÜSTÜ SÜRME KASA

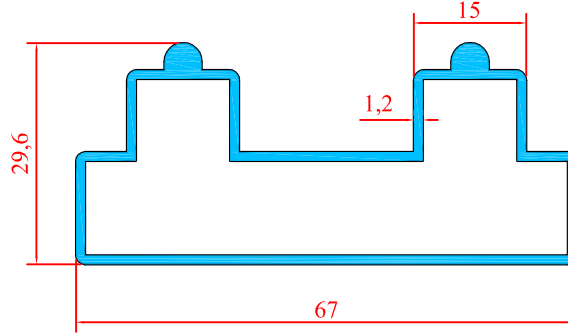

2141

1.982 Kg/m  
GENİŞ SÜRME KANAT

